

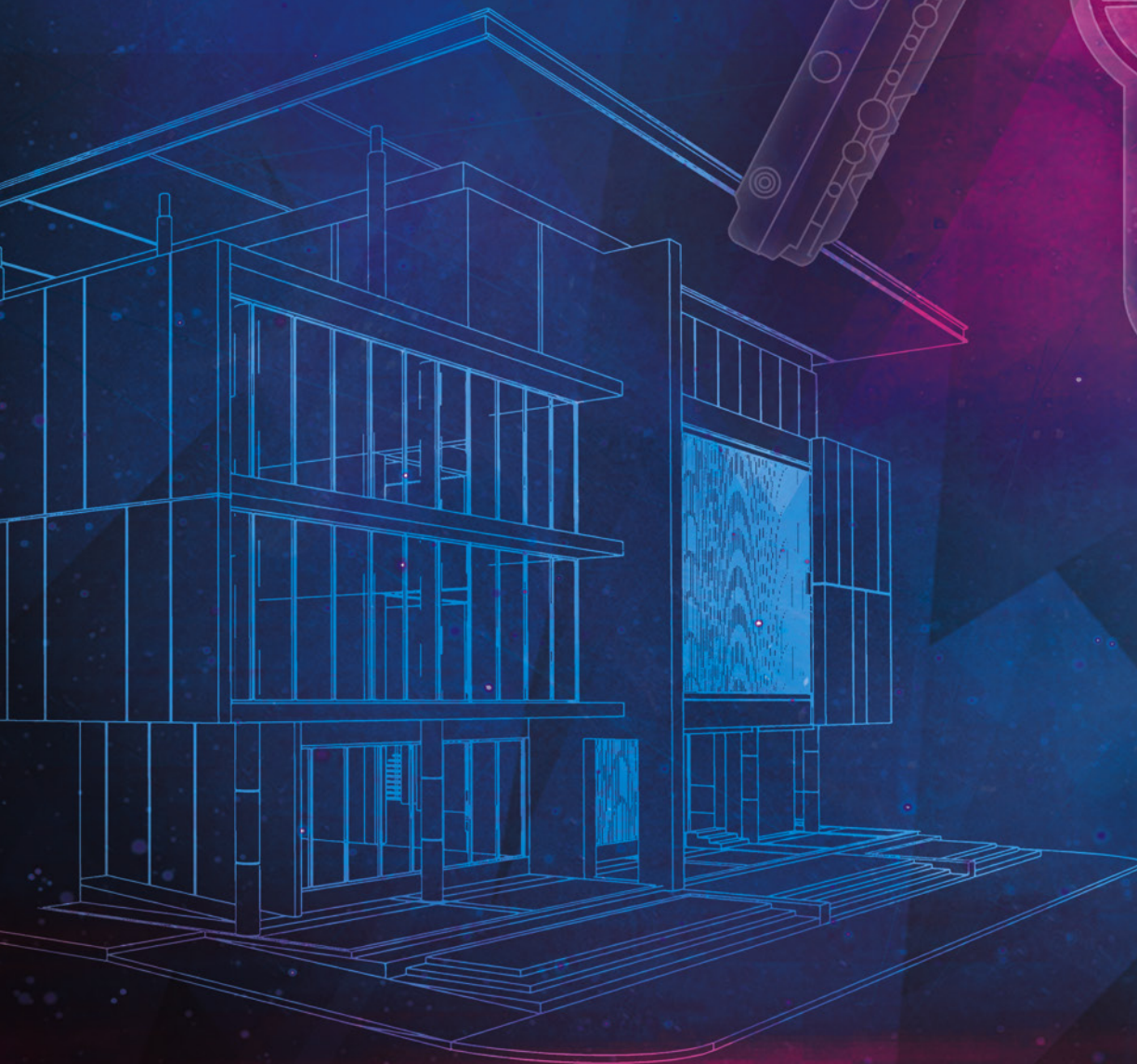

Cylinders, keys  
and access  
control systems





# CISA solutions for building security

CISA guarantees buildings are secure and people are safe, thanks to its complete access control solutions.

## Houses and apartment buildings



## Schools and universities



## Hotels and B&Bs



## Hospitals



## Offices and companies



Learn more about CISA solutions at:

[cisa.com](https://www.cisa.com)



# Protecting your peace of mind

Choosing the right cylinder is an essential part of protecting buildings and guaranteeing peace of mind for the people who live and work there. CISA offers a wide range of cylinders with different levels of security which effectively protect against external attacks and key duplication.

## Keyed alike systems

Access control in public, commercial and residential buildings guarantees flexibility, security and convenience. With CISA's master key systems, one key opens all entrances (doors, gates, garages....). Access can also be managed according to a hierarchy: only authorised people have access to certain areas.



# Passive security: protecting against forced entry

Feeling safe in your own home and protecting your personal belongings with strong, secure solutions has become a fact of life.

CISA cylinders are fitted with special devices which protect your home against forced entry and meet the **highest security standards.**



## 1 Resistance to tearing: Snap Resistant System

A patented bi-material steel core which is also visible when the cylinder is installed on the door. It guarantees high resistance to tearing and pulling: +40% more than conventional cylinders.



## 2 Resistance to 'picking'

Thanks to a key biting system with new special drivers which protect against picklocks.



## 3 Resistance to bumping: BKP

The "Bump Key Power" device increases cylinder resistance to forced entry using "bumping" (percussion) techniques. The special configuration of the springs also means it is highly resistant to the wax impression technique used to force entry.



## 4 Resistance to drilling

Depending on the model, CISA cylinders contain one or more parts (pins, drivers and inserts) in hardened steel, positioned on both sides of the cylinder, which act as an effective deterrent against drill attacks.



# Active security: key duplication

How often do we give our keys to others (tradesmen, cleaners, etc.) who could easily duplicate them and use them without our permission?

CISA guarantees maximum security, thanks to solutions which legally protect key duplication.

**Patented products ensure greater security because a patented key cannot be freely reproduced, but only with the owner's consent.**

Distribution of blank keys is therefore controlled and duplication is safe.

## **CISA Security Card Protected key duplication**

The Security Card has an univocal code linked to the key and must be presented when requesting a duplicate of a patented key. Authorised CISA dealers or CISA Solution Partners will only issue a duplicate key upon presentation of the card.











**CISA®**



**Astral Tekno Centres**

Astral Tekno Centres are centres which are authorised by CISA to duplicate keys upon presentation of the Security Card and are located throughout Italy.



**CISA®**



**C3000 Centres**

C3000 Centres are centres which are authorised by CISA to duplicate keys upon presentation of the Security Card and are located throughout Italy.





# Master key systems

Master key systems are essential in complex facilities where, as the number of people, locks and rooms increases, it becomes necessary to control access using keys with different levels of authorisation.

Master key systems reduce the number of keys in circulation and make organisation and control a lot easier.

A master key system can be configured to meet the different needs of residential or non-residential buildings.

It is ideal for private homes and large apartment buildings because it is both practical and secure and means no more heavy bunches of keys. A single key, with a personalised combination, opens both private and communal accesses.

It is an advantage for non-residential buildings because there are fewer keys to manage and hierarchy and access control throughout the building are easier.

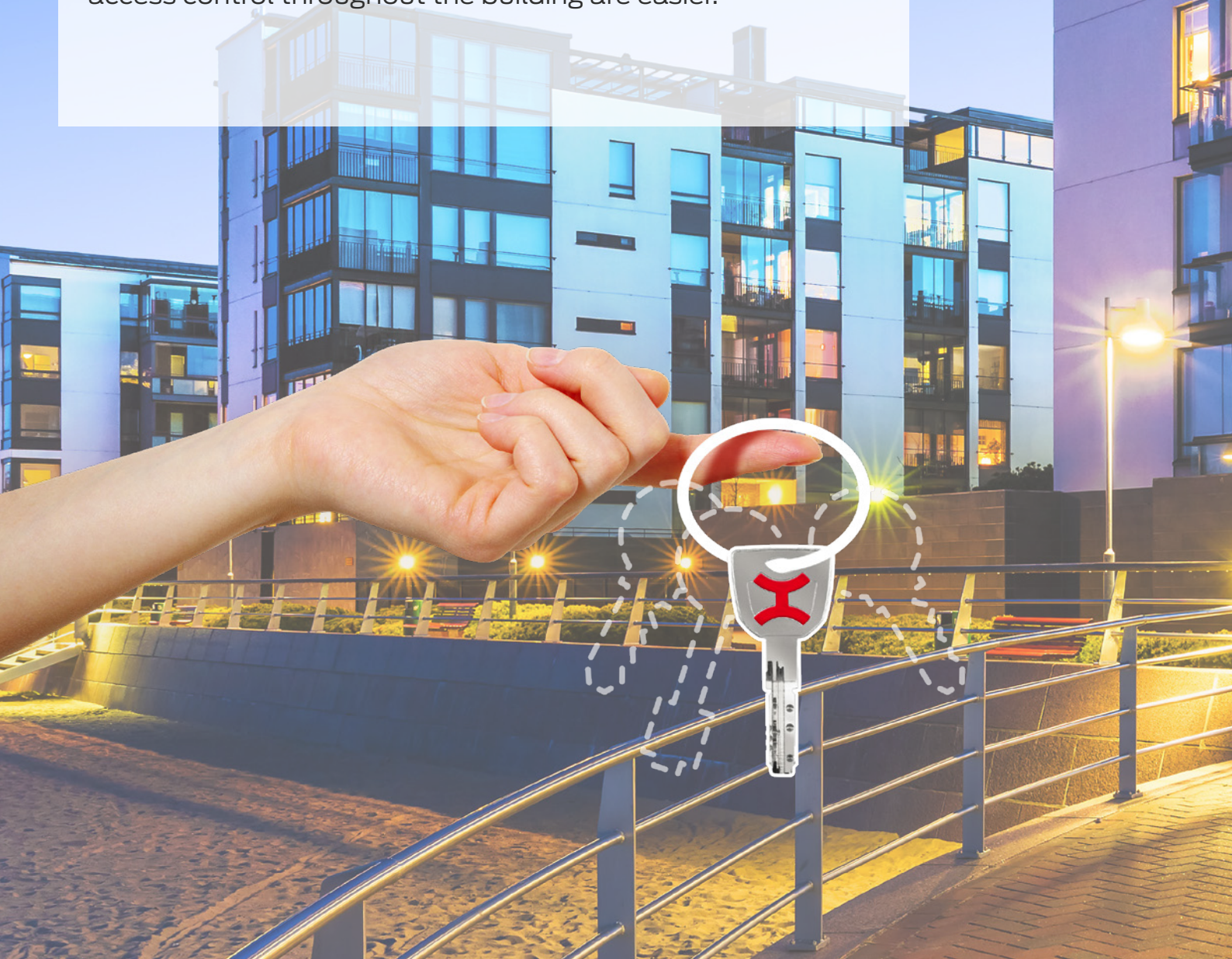



# 4 different systems

**Residential buildings:** single-family houses and apartment buildings

KA

KEYED ALIKE  
SYSTEM

One key opens all doors in the home.



CE

COMMON ENTRANCE  
SYSTEM

The key opens your apartment door and all communal areas.



**Non-residential buildings:** schools, companies, hospitals, hotels

MK

MASTER KEY  
SYSTEM

Every key opens its own door. The master key opens all doors.



GMK

GRAND MASTER  
KEY SYSTEM

The GMK system provides hierarchical access control.





# Systems for residential buildings

## KA

KEYED ALIKE  
SYSTEM

The KA system is the ideal solution for single-family houses because you can manage all the accesses in your home, such as the front door, gate and garage, with a single key.



## CE

COMMON ENTRANCE  
SYSTEM

The CE system is ideal for apartment buildings because you can manage all the private accesses to your apartment, as well as the communal entrances, such as the pedestrian gate and the main entrance door, with a single key. It ensures maximum security because only the owner can enter his home.



# Systems for non-residential buildings

## MK

MASTER KEY SYSTEM

The MK system is the ideal solution when controlling access in small and medium-sized buildings such as companies and hotels, as the flow of people is organised in a secure manner in groups.

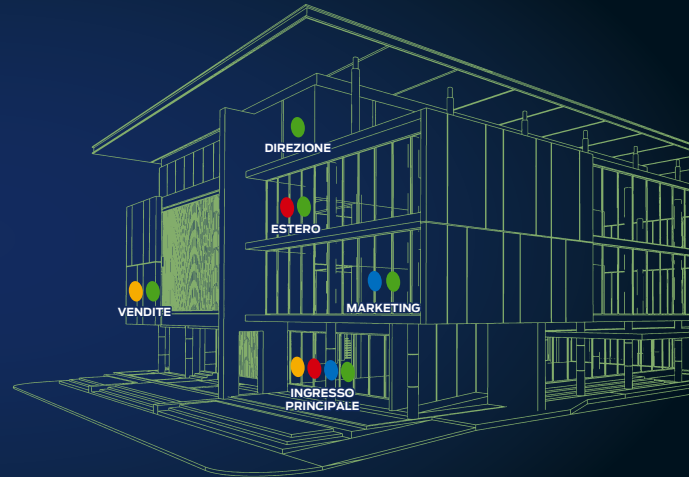

## GMK

GRAND MASTER KEY SYSTEM

The GMK system is ideal for organising and managing access to departments of large complexes, such as hospitals and schools, where access must be controlled hierarchically according to people's responsibilities and roles.

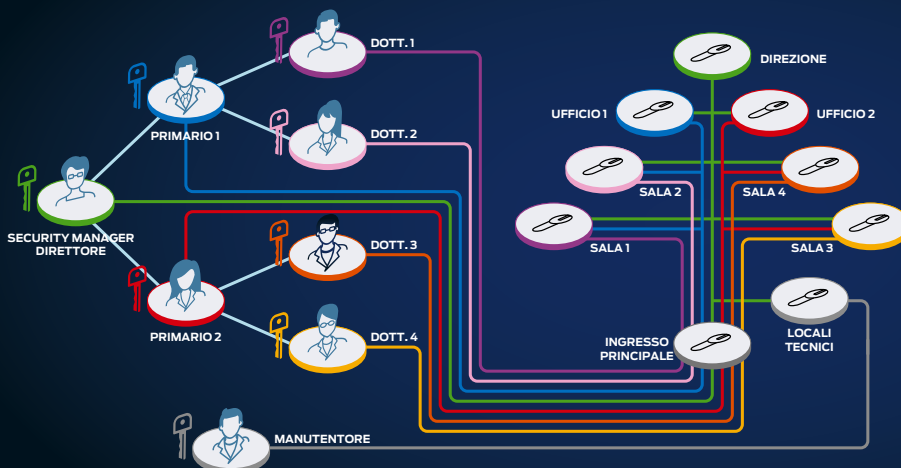



# Certifications

ICIM certification, in compliance with EN1303, guarantees cylinder performance through documental checks of the technical specifications, in-company inspections, sample testing and yearly inspections.

European Standard EN1303 sets forth operation and requirements regarding the security and reliability of cylinders and their original keys.

This certification offers a variety of benefits: for armoured door manufacturers it becomes faster and cheaper to certify armoured doors according to EN1627, as the certificate makes tests on the cylinder unnecessary. Certification is important for distributors, as there are fewer risks of the door degrading due to replacement of the cylinder supplied.

CISA certified cylinders Asix P8, Astral S, Astral Tekno PRO, C3000 S, AP4 S and RS3 S guarantee compliance to performance over time as set out in EN1303.

**ACCREDIA**  
PDR N° 0018  
Member degli Accordi di Mutual Recognition DA, SP e SAC  
Signatory of DA, SP and SAC Mutual Recognition Agreements

**ICIM**

**Certificazione di Prodotto**  
*Product Certification*

Certificato N. **ICIM-CLD-000047-01**  
Certificate No.

ALL'AZIENDA / TO THE FIRM  
**CISA S.p.A.**  
Via Oberdan, 42  
48018 FAENZA (RA) ITALY

UNITÀ OPERATIVE / OPERATIVES UNITS  
Via C. Colombo, 110  
MONSAMPOLO DEL TRONTO (AP) - IT

PER I SEGUENTI PRODOTTI / FOR THE FOLLOWING PRODUCTS  
**CILINDRO PER SERRATURE**  
**CYLINDER FOR LOCKS**

CON DENOMINAZIONE COMMERCIALE / WITH TRADE NAMES  
**serie AP4S - Sigillo**  
1-0P3S1-xx-0-xx-xx-xx  
1-0P3S2-xx-0-xx-xx-xx  
1-0P3S7-xx-0-xx-xx-xx  
1-0P314-xx-0-xx-xx-xx

CONFORMEMENTE ALLA NORMA ED AL DOCUMENTO NORMATIVO ICIM  
IN COMPLIANCE WITH THE STANDARD AND WITH ICIM NORMATIVE DOCUMENT

**UNI EN 1303:2015 - ICIM 0039CS**

CON CLASSIFICAZIONE / WITH CLASSIFICATION  
**1 | 6 | 0 | B | 0 | C | 6 | D | 1**

REQUISITI ULTERIORI ICIM 0039CS / ICIM 0039CS ADDITIONAL REQUIREMENTS  
ANTI-PICKING: Pass  
ANTI-SHIMMING: Grado 3

Vincento Dielsacqui  
Rappresentante Disciplinare / Management Representative  
**ICIM S.p.A.**

PRIMA EMISSIONE / FIRST ISSUE: **17/11/2017**  
EMISSIONE CORRENTE / CURRENT ISSUE: **17/11/2020**  
DATA DI SCADENZA / EXPIRING DATE: **16/11/2023**

00000000\_00\_IT  
ICIM S.p.A. - Piazza Don Enrico Magelli, 75 - 20089 Sesto San Giovanni (MI)



# The European Standard

## IN COMPLIANCE WITH EN 1303: 15

<b>Key Related Security:</b>	1	2	3	4	5	6
<b>Attack Resistance:</b>	0	A	B	C	D	
<b>Durability:</b>	4	5	6			

### SECURITY

Cylinder and key resistance to forced entry  
(European standard EN 1303: 15  
Key Related Security - Attack Resistance).

### RELIABILITY

Resistance of the cylinder over time and to wear  
(European standard EN 1303: 15 - Durability).





A cylinder for every need

















## How to choose the right cylinder

CISA recommends choosing a cylinder based on a scale from 1 to 7 which takes the following parameters into account:

	<b>Resistance to picking</b> Thanks to special pins and drivers
	<b>Resistance to bumping</b> Thanks to the "Bump Key Power" system or the fact it is impossible to obtain key blanks as with RS3 S NEW
	<b>Resistance to tearing</b> With the Snap Resistant system, steel core, or snaps at a redetermined point as with Astral Tekno PRO
	<b>Resistance to drilling</b> With parts such as pins, drivers and inserts in hardened steel positioned on both sides of the cylinder
	<b>Cylinder with clutch system</b> Thanks to the clutch-type follower, the door can be opened from the outside even if the key is in the door inside
	<b>Protected duplication</b> Keys can only be duplicated upon presentation of the Security Card
	<b>Combinations</b> The maximum number of different keys/cylinders

RS3 S	AP4 S	ASTRAL TEKNO
1 2 3 4 5 6 7	1 2 3 4 5 6 7	1 2 3 4 5 6 7
✓	✓	✓
✓	✓	✓
✓	✓	✓
✓	✓	✓
✓	✓	✓
✓	✓	✓
<b>8 billion</b>	<b>40 million</b>	<b>1.6 million</b>



ASTRAL S	C3000 S	C3000	ASIX P8	ASIX	C2000
					
					
					
✓	✓	✓	✓		
✓	✓	✓	✓		
✓	✓	✓	✓		
✓	✓	✓	✓	✓	✓
✓	✓	✓	✓		
	✓	✓			
1.6 million	240,000	240,000	260,000	30,000	30,000

## PATENTED SYSTEM

# RS3 S



### KEY FEATURES

- Keys can only be duplicated by CISA upon presentation of the Security Card.
- Mobile part of the key protected by a shape trademark.
- Emergency function, thanks to the clutch system supplied.
- Certified Attack Resistance grade D, for armoured doors classified 4 to 6 according to EN1627-2011.

### CYLINDER SECURITY

- High resistance to pulling and tearing, thanks to the Snap Resistant feature, a bi-material steel core which is also visible when the cylinder is installed on the door.
- High resistance to bumping or percussion as it is impossible to obtain key blanks, it is difficult to tamper with existing bitted keys to obtain a "power key" and it has a large number of small pins set out radially.
- High resistance to forced entry using the wax impression technique, thanks to the high number of small pins set out radially.
- High drill resistance, due to the key biting system (pins and drivers) in hardened steel.

### KEY SECURITY

- Patented key, protected against illegal production.
- More difficult to clone as it is equipped with a mobile shaped part.
- Radial key biting system, up to 19 pins on 5 rows.
- Up to 8 billion possible combinations, that is different keys.

### MASTER KEYING POTENTIAL

- Maximum capacity, thanks to the radial key biting system, up to 19 pins on 5 rows.
- Up to 85 million different cylinders per master key. Other configurations available on request.

### RELIABILITY

- Tested up to 100,000 cycles.

### PATENTS AND CERTIFICATION



- Keys: patent PCT/EP1728944.
- Snap Resistant system: European patent EP1583878, Russian patent RU2361989.
- ALI key: with shape trademark BO2004C0000802.

### SECURITY LEVEL





# RS3 S Modulo

## PATENTED SYSTEM



On-site installation



Assembled in under a minute



Offers same resistance as RS3 S

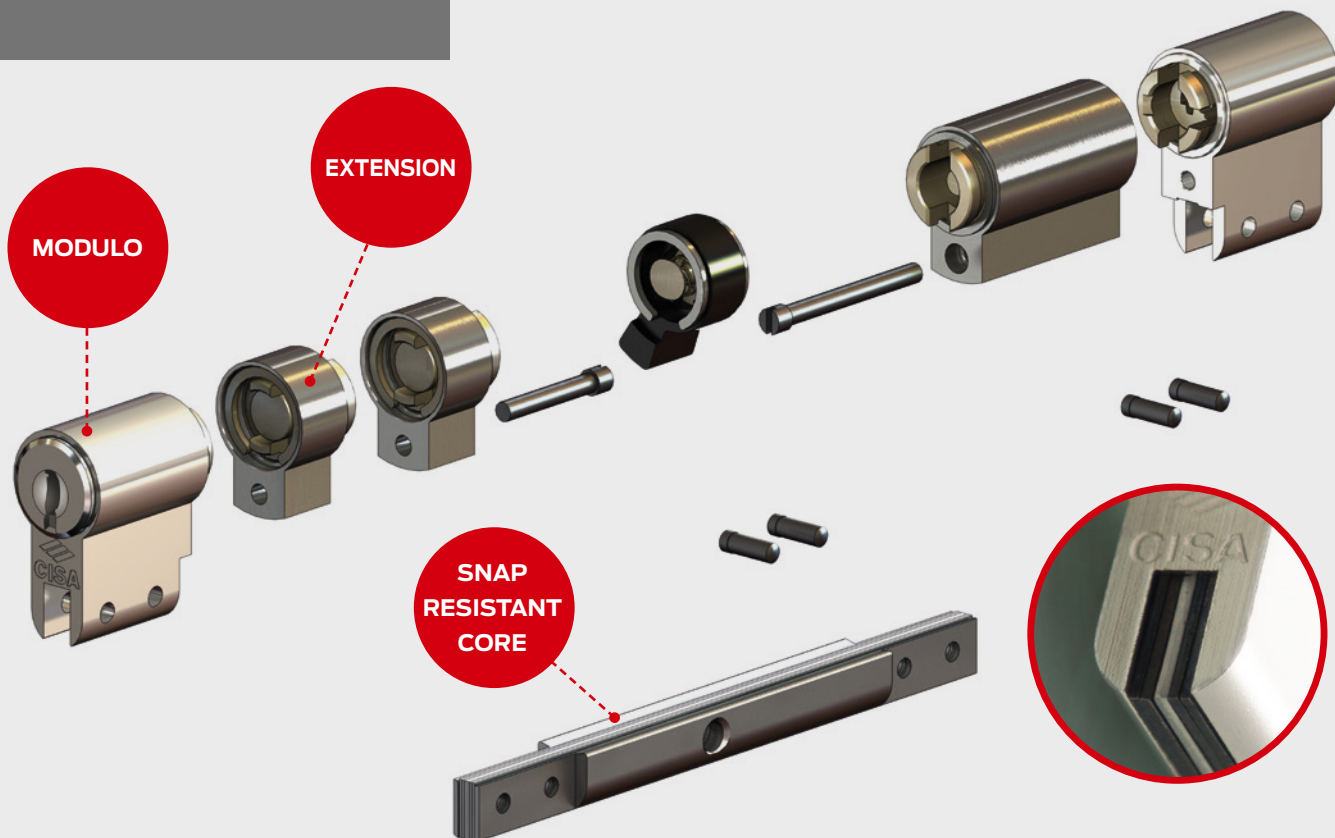

### BOOSTS YOUR BUSINESS, STREAMLINES AND SIMPLIFIES YOUR STOCK

Thanks to its special configuration, RS3 S Modulo maximises business opportunities without any extra stock requirements, reducing the risk of slow-moving stock and improving customer service.

Whatever the door thickness and the lock position, RS3 S Modulo will guarantee on-site installation or replacement in less than a minute.

RS3 S Modulo is ready for use: the special pre-keyed, factory tested module system, which comes with keys and a Security Card, and the pre-assembled extended bolt units make RS3 S Modulo quick and easy to install.

RS3 S Modulo guarantees the same resistance as RS3 S, with the same resistance to pulling and tearing thanks to the Snap Resistant system: +40% more than conventional cylinders.

### RS3 S MODULO INSTALLATION KIT

The CISA RS3 S Modulo comes with a case with the cylinder parts in the most commonly used sizes and the tools needed to install the cylinder on site.



## PATENTED SYSTEM

# AP4 S



### KEY FEATURES

- Keys can only be duplicated by CISA or CISA Solution Partners upon presentation of the Security Card.
- Key is more difficult to clone thanks to the sprung mobile part which is protected by a shape trademark.
- Certified Attack Resistance grade D, for armoured doors classified 4 to 6 according to EN1627.

### CYLINDER SECURITY

- High resistance to pulling and tearing, thanks to the Snap Resistant feature, a bi-material steel core which is also visible when the cylinder is installed on the door.
- High resistance to “bumping” or percussion, thanks to the BKP (Bump Key Power) device.
- High resistance to forced entry using the wax impression technique, thanks to the special configuration of the springs.
- High drill resistance, thanks to the hardened steel key bitting system (all the pins, drivers and inserts are positioned on both sides of the cylinder).
- High resistance to “picking”, thanks to the system with new special drivers.

### KEY SECURITY

- Patented key, protected against illegal production.
- Key is difficult to clone thanks to the sprung mobile part which is protected by TRADEMARK, providing unlimited protection over time.
- Security Card for authorised key duplication by CISA Solution Partners and CISA.

### MASTER KEYING POTENTIAL

- The 11-pin key bitting system offers excellent access management potential (for example: 132,000 different cylinders with one master key.).
- The key bow can be personalised with an insert available in 15 different colours.

### RELIABILITY

- Tested up to 100,000 cycles.

### PATENTS AND CERTIFICATIONS



- Key: patent PCT/IT2013/000297-AP4.
- Key: 3D TRADE MARK: 1276648
- cylinder: Snap Resistant patent EP1583878
- cylinder: BKP patent PCT/WO2007/074163A1
- cylinder: picking patent PCT/IT2016/000093

### SECURITY LEVEL



## PATENTED SYSTEM

# MODULO SYSTEM

AP4 S  
Astral S  
C3000 S

## The business-boosting solution that has limited impact on your stock

CISA's Modulo System platform uses parts belonging to the AP4 S, Astral S and C3000 S ranges, so your cylinder can be assembled and installed directly on-site, guaranteeing you the best solution for your needs without any extra stock requirements.

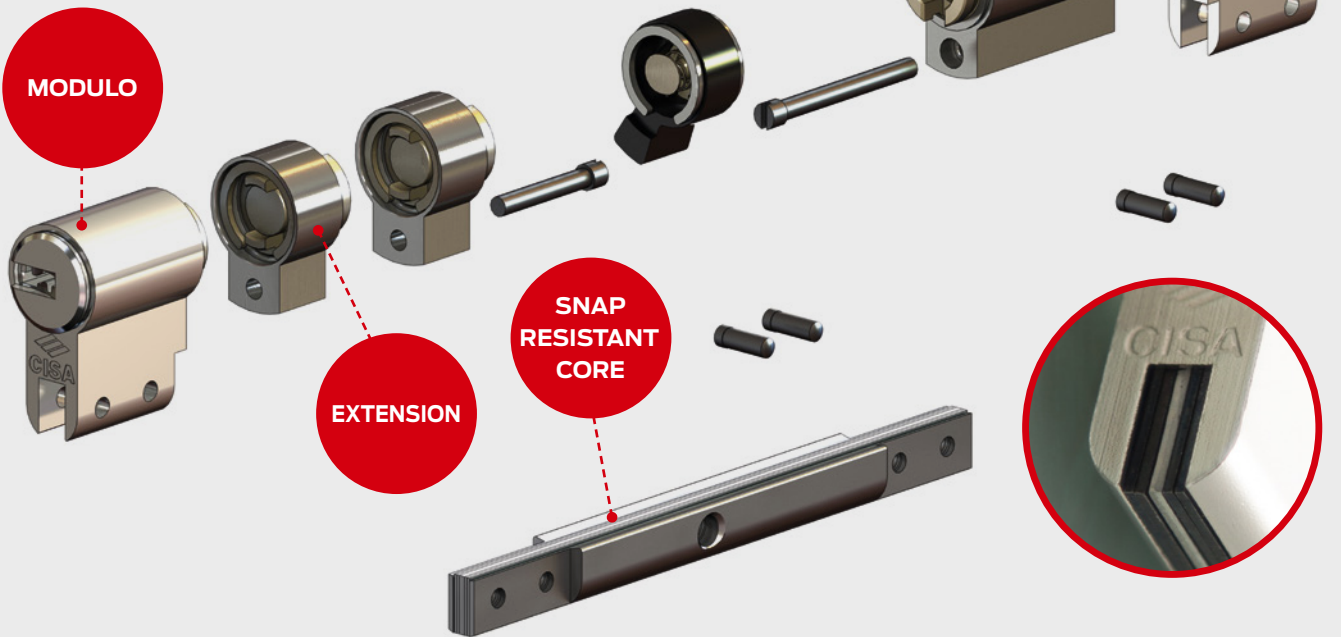

### Flexible

Complete modules in the KA, CE and CA configurations are readily available, even cylinders for special applications which are not normally kept in stock.



### Secure

The Modulo System guarantees high security: the patented bi-material steel core from the Snap Resistant system increases resistance to pulling and tearing by 40% compared to conventional cylinders.



### Instant

This special system with pre-assembled and factory tested modules and extensions means cylinders can be assembled in less than a minute without the need for a site inspection beforehand.

## THE MODULO PLATFORM IS COMPATIBLE WITH: SYSTEM



### AP4 S

#### Patented system

Reversible key with mobile part, patented and protected by 3D trademark, can only be duplicated by CISA Solution Partners or CISA.



### ASTRAL S

Reversible key, free duplication.

Over 1,600,000 possible combinations (different keys)



### C3000 S

#### Protected system

Key protected by 3D trademark, can only be duplicated by CISA or at CISA authorised centres.





## PATENTED SYSTEM

# Astral Tekno PRO



### KEY FEATURES

- Keys can only be duplicated at CISA or CISA Astral Tekno Centres upon presentation of the Security Card.
- Key with ergonomic plastic insert.
- Wide range of personalised profiles.
- Emergency function, thanks to the clutch system supplied.

### CYLINDER SECURITY

- Protection against pulling and tearing. In the event of attempted forced entry, the cylinder snaps at a predetermined point, protecting the heart of the cylinder which remains inside the lock and therefore difficult to remove. If the cylinder snaps in this way, it is still possible to open the door from the outside with the keys.
- High resistance to “bumping” or percussion, thanks to the BKP (Bump Key Power) device.
- High resistance to forced entry using the wax impression technique, thanks to the special configuration of the springs.
- High drill resistance, thanks to the hardened steel key bitting system (all the pins, drivers and inserts are positioned on both sides of the cylinder).

### KEY SECURITY

- Patented key, greater protection against illegal production.
- Security Card for authorised key duplication by CISA and CISA authorised centres.
- 10-pin key bitting system on 2 rows.
- Over 1,600,000 possible combinations or different keys.

### MASTER KEYING POTENTIAL

The 10-pin key bitting system offers excellent access management potential (for example: 63,000 different cylinders with one master key.).

### RELIABILITY

- Tested up to 100,000 cycles.

### PATENTS AND CERTIFICATIONS



- Key: patent PCT/EP99/ 07611.
- BKP: patent PCT/WO2007/074163A1.

### SECURITY LEVEL



# Astral S



## KEY FEATURES

- Emergency function, thanks to the clutch system supplied.
- Certified Attack Resistance grade D, for armoured doors classified 0 to C according to EN1627.

## CYLINDER SECURITY

- High resistance to pulling and tearing, thanks to the Snap Resistant feature, a bi-material steel core which is also visible when the cylinder is installed on the door.
- High resistance to “bumping” or percussion, thanks to the BKP (Bump Key Power) device.
- High resistance to forced entry using the wax impression technique, thanks to the special configuration of the springs.
- High drill resistance, thanks to the hardened steel key bitting system (all the pins, drivers and inserts are positioned on both sides of the cylinder).

## KEY SECURITY

- 10-pin key bitting system on 2 rows.
- Over 1,600,000 possible combinations or different keys.

## MASTER KEYING POTENTIAL

The 10-pin key bitting system offers excellent access management potential (for example: 63,000 different cylinders with one master key.).

## RELIABILITY

- Tested up to 100,000 cycles.

## PATENTS AND CERTIFICATIONS



- Snap Resistant system: European patent EP1583878, Russian patent RU2361989.
- BKP: patent PCT/WO2007/074163A1.

## SECURITY LEVEL



# C3000 S



## KEY FEATURES

- Traditional key in nickel silver alloy protected by trademark.
- Keys can only be duplicated at CISA or CISA C3000 Centres upon presentation of the Security Card.
- Emergency function, thanks to the clutch system supplied.

## CYLINDER SECURITY

### Attack Resistance

- High resistance to pulling and tearing, thanks to the Snap Resistant feature, a bi-material steel core which is also visible when the cylinder is installed on the door.
- High resistance to “bumping” or percussion, thanks to the BKP (Bump Key Power) device.
- High resistance to forced entry using the wax impression technique, thanks to the BKP device and the special configuration of the springs.
- High drill resistance, thanks to the hardened steel key biting system and plug inserts.

## KEY SECURITY

### Key Related Security

- Key protected by 3D trademark for greater protection against illegal key duplication.
- Security Card for authorised key duplication by CISA and CISA authorised centres.
- Over 240,000 possible combinations or different keys.

## MASTER KEYING POTENTIAL

- The 6-pin key biting system offers excellent access management potential. For example: 15,000 different cylinders with one master key.
- C3000 S and C3000 cylinders are compatible because it is possible to use the same key on both cylinders when managing access.

## RELIABILITY

- Tested for more than 100,000 cycles.

## PATENTS AND CERTIFICATIONS



- In compliance with EN 1303: 2015 160BOC6D.
- Key protected by 3D trademark 1 236 248 and Community Design registered at no. 2669630.
- BKP device: patent PCT/WO 2007/074163 A1.
- Snap Resistant System patent EP1583878.

## SECURITY LEVEL





# C3000



## KEY FEATURES

- Traditional key in nickel silver alloy protected by trademark.
- Keys can only be duplicated at CISA or CISA C3000 Centres upon presentation of the Security Card.

## CYLINDER SECURITY

### Attack Resistance

- High resistance to “bumping” or percussion, thanks to the BKP (Bump Key Power) device.
- High resistance to forced entry using the wax impression technique, thanks to the BKP device and the special configuration of the springs.
- High drill resistance, thanks to the hardened steel key bitting system (pins, drivers and inserts).
- Push resistance due to the projecting cam.

## KEY SECURITY

### Key Related Security

- Key protected by 3D trademark for greater protection against illegal key duplication.
- Security Card for authorised key duplication by CISA and CISA authorised centres.
- Over 240,000 possible combinations or different keys.

## MASTER KEYING POTENTIAL

- The 6-pin key bitting system offers excellent access management potential. For example: 15,000 different cylinders with one master key.
- C3000 S and C3000 cylinders are compatible because it is possible to use the same key on both cylinders when managing access.

## RELIABILITY

- Tested up to 100,000 cycles.

## PATENTS AND CERTIFICATIONS



- Key protected by 3D trademark 1 236 248 and Community Design registered at no. 2669630.
- BKP device: patent PCT/WO 2007/074163 A1.

## SECURITY LEVEL



# Asix P8



## KEY FEATURES

- Emergency function, thanks to the clutch system supplied (excluding the version with construction key).
- Certified Attack Resistance grade C, for armoured doors classified 0 to C according to EN1627.
- Key bow with ergonomic removable plastic insert.

## CYLINDER SECURITY

- Certified protection against bumping, thanks to the patented BKP (Bump Key Power) technology.
- Certified protection against drilling, thanks to the bitting system in carbonitrided steel.
- High resistance to forced entry using the wax impression technique, thanks to the special configuration of the springs.

## KEY SECURITY

- 8-pin key bitting system on 2 rows.
- Over 260,000 possible combinations (different keys).

## SECURITY LEVEL



## MASTER KEYING POTENTIAL

The 8-pin key bitting system offers excellent access management potential: 37,000 different cylinders with one master key.

## RELIABILITY

- Tested up to 100,000 cycles.

## PATENTS AND CERTIFICATIONS



- BKP: patent PCT/WO 2007/074163A1.

## Asix P8 PRO



### Construction key function

- When AsixP8 is configured as a construction key, it becomes AsixP8 PRO, the ideal solution when armoured doors requiring basic security are to be installed.
- The first time the owner of the apartment or office uses his master key, the construction key is rendered inoperative.

# Asix



## CYLINDER SECURITY

- Drill resistance with the first pin and driver in hardened steel.
- Push resistance due to the projecting cam.

## KEY SECURITY

- 6-pin key bitting system.
- Over 30,000 possible combinations or different keys.

## RELIABILITY

- Tested up to 100,000 cycles.

## SECURITY LEVEL



# C2000



## CYLINDER SECURITY

- Drill resistance with the first pin and driver in hardened steel.
- Push resistance due to the projecting cam.

## KEY SECURITY

- 5-pin key bitting system, depth 0.44 mm.
- Over 30,000 possible combinations or different keys.

## RELIABILITY

- Tested up to 100,000 cycles.

## SECURITY LEVEL





# CISA cylinders for special applications.

■ Available for all the ranges of CISA cylinders.



Cylinder for locks  
installed on  
wooden doors



Cylinder for  
locks installed  
on steel doors



Cylinder for  
letter boxes



Cylinder set for  
pedestrian gates



Cylinder with  
microswitch for  
motorised gates



Cylinder for armoured  
padlocks

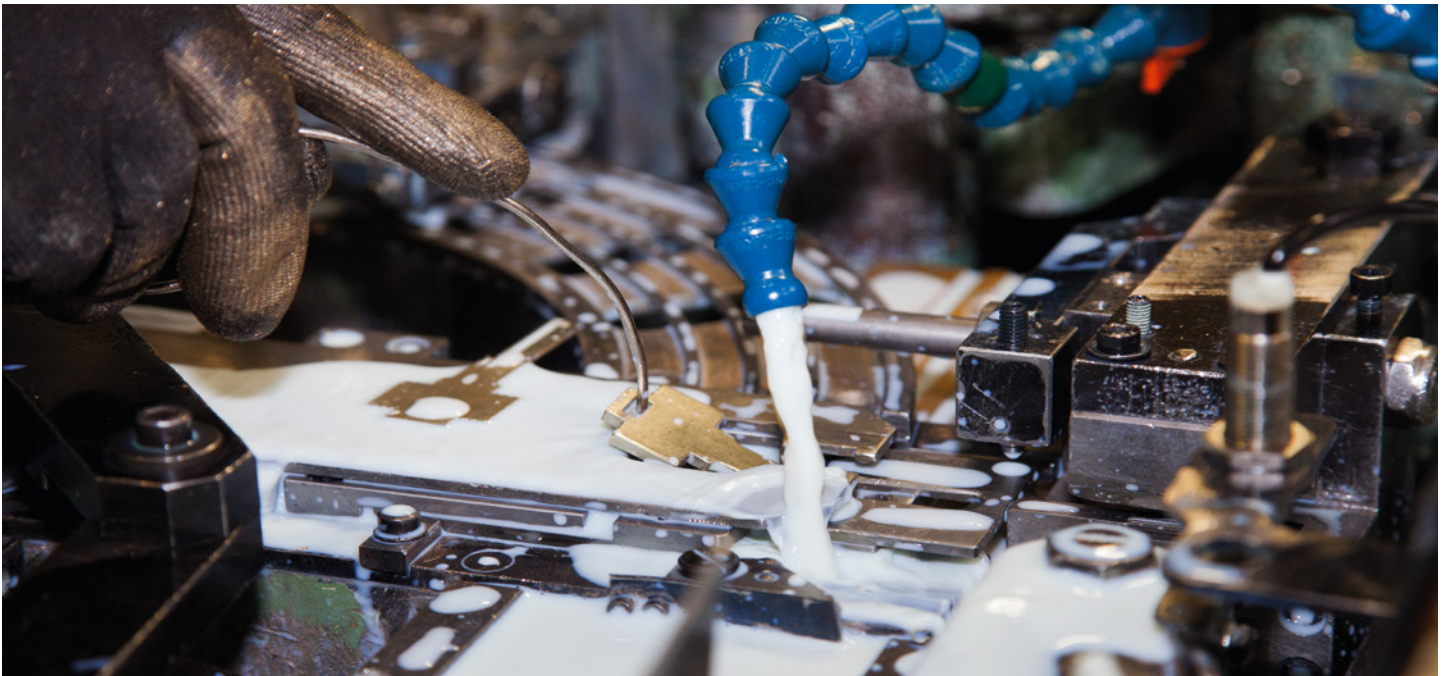

Photographs taken at CISA headquarters in Faenza (RA) and Monsampolo (AP) - Italy

## About Allegion

Allegion (NYSE: ALLE) is a global pioneer in seamless access, with leading brands like CISA®, Interflex®, LCN®, Schlage®, SimonsVoss® and Von Duprin®. Focusing on security around the door and adjacent areas, Allegion secures people and assets with a range of solutions for homes, businesses, schools and institutions.





For more, visit [allegion.com](https://allegion.com).



 CISA SpA  
Via Oberdan 42  
48018 Faenza (RA) Italy

 Ph. +39 0546 677111  
Fax +39 0546 677150

 Customer Service and Technical Support  
+39 0546 188 0070

    [cisa.com](https://cisa.com)  
[cisa.sales@allegion.com](mailto:cisa.sales@allegion.com)